

TUMBLE ACTION WASHER

Use & Care Guide

Machine à laver par culbutage

Guide de L'utilisateur

Table of Contents

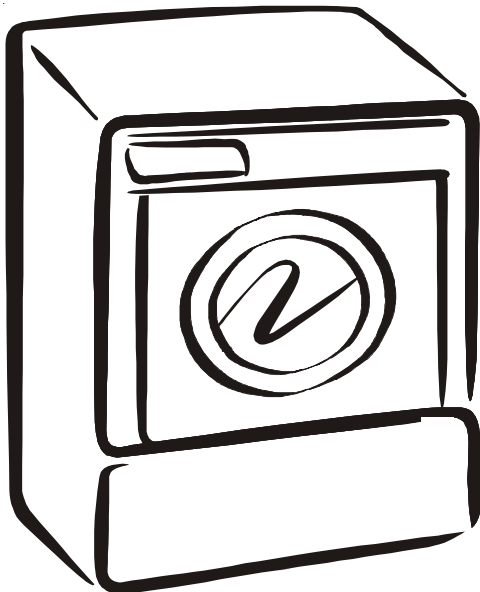

IMPORTANT SAFETY INSTRUCTIONS	2-3
Washing Procedures	3-4
Stain Removal	5
Common Washing Problems	6
Care and Cleaning	7
Avoid Service Checklist	8
Warranty.....	9
Français.....	10-18
Consignes de sécurité importantes.....	10-11
Instructions de lavage.....	11-12
Détachage	13
Problèmes de lessive courants.....	14
Entretien et nettoyage	15-16
Guide de dépannage	16-17
Garantie	18
Back Cover.....	20

The symbol  on the product or on its packaging indicates that this product may not be treated as household waste. Instead it shall be handed over to the applicable collection point for the recycling of electrical and electronic equipment. By ensuring this product is disposed of correctly, you will help prevent potential negative consequences for the environment and human health, which could otherwise be caused by inappropriate waste handling of this product. For more detailed information about recycling of this product, please contact your local city office, your household waste disposal service or the shop where you purchased the product.

Le symbole  sur le produit ou son emballage indique que ce produit ne peut être traité comme déchet ménager. Il doit être remis au point de collecte dédié à cet effet (collecte et recyclage du matériel électrique et électronique). En procédant à la mise à la casse réglementaire de l'appareil, nous préservons l'environnement et notre sécurité, s'assurant ainsi que les déchets seront traités dans des conditions appropriées. Pour obtenir plus de détails sur le recyclage de ce produit, veuillez prendre contact avec les services de votre commune ou le magasin où vous avez effectué l'achat.

Read all instructions before using this appliance. This book contains valuable information about

- Operation
- Care
- Service

Keep it in a safe place.

Lisez ce manuel en entier avant de vous servir de cet appareil. Ce manuel renferme de précieuses informations sur

- le fonctionnement
- l'entretien
- le service après-vente

Conserver en lieu sûr.

Read and Save These Instructions

Record Your Model and Serial Numbers

The model and serial numbers of your washer are found on the washer serial plate located at the top, inside of the door opening. Record and retain these numbers.

Lire et conserver ces instructions

Noter les numéros de modèle et de série

Les numéros de modèle et de série de la laveuse se trouvent sur la plaque signalétique à dans la partie supérieure à l'intérieur de l'ouverture de la porte. Noter et conserver ces numéros.

Model Number

N° de modèle _____

Serial Number

N° de série _____

Purchase Date

Date de l'achat _____

This Use and Care Guide provides general operating instructions for your washer. It also contains information about features for several other models. Your washer may not have every feature included here.

Use the washer only as instructed in this Use and Care Guide and the **Operating Instructions** included with your washer.

Your safety and the safety of others is very important.

We have provided many important safety messages in the Use and Care Guide, Operating Instructions, Installation Instructions and on your appliance. Always read and obey all safety messages.

⚠ This is the safety alert symbol. This symbol alerts you to hazards that can kill or hurt you or others. All safety messages will be preceded by the safety alert symbol and the word "DANGER" or "WARNING". These words mean:

⚠ DANGER You will be killed or seriously injured if you don't follow instructions.

⚠ WARNING You can be killed or seriously injured if you don't follow instructions.

All safety messages will identify the hazard, tell you how to reduce the chance of injury, and tell you what can happen if the instructions are not followed.

Pedestal

A pedestal accessory, **Model No. NLPWD15 (White), NLPWD15GB (Glacier Blue), NLPWD15P (Platinum) and NLPWD15E (Black)**, specifically designed for this washer may be used when elevating the washer for ease of use. Failure to use accessories certified by the manufacturer could result in personal injury, property damage or damage to the washer.

Important Safety Instructions

SAVE THESE INSTRUCTIONS

Read all instructions before using this washer.

⚠ WARNING To reduce the risk of fire, electrical shock, or injury to persons when using this washer, comply with the basic warnings listed below.

⚠ Failure to comply with these warnings could result in serious personal injuries.

Prevent Fire

⚠ WARNING Do not wash items that have been previously cleaned in, soaked in, or spotted with gasoline, cleaning solvents, kerosene, cooking oils, waxes, etc. Do not store these items on or near the washer. These substances give off vapors or chemical reactions that could ignite or explode.

⚠ WARNING Do not put oily or greasy rags or clothing on top of the washer. These substances give off vapors that could ignite the materials.

⚠ WARNING Do not add gasoline, cleaning solvents, or other flammable or explosive substances to the wash water. These substances give off vapors that could ignite or explode.

⚠ WARNING Under certain conditions, hydrogen gas may be produced in a hot water system that has not been used for 2 weeks or more. **HYDROGEN GAS IS EXPLOSIVE.** If the hot water system has not been used for such a period, before using the washer, turn on all hot water faucets and let the water flow from each for several minutes. This will release any accumulated hydrogen gas. Hydrogen gas is flammable; do not smoke or use an open flame during this time.

⚠ WARNING Do not store or use gasoline or other flammable vapors or liquids in the vicinity of this or any other appliance.

⚠ Failure to comply with these warnings could result in fire, explosion, serious bodily injury and/or damage to the rubber or plastic parts of the washer.

Protect Children

⚠ WARNING Do not allow children to play on or in the washer. Close supervision of children is necessary when the washer is used near children. As children grow, teach them the proper, safe use of all appliances.

⚠ WARNING Destroy the carton, plastic bag and other packing materials after the washer is unpacked. Children might use them for play. Cartons covered with rugs, bedspreads or plastic sheets can become airtight chambers.

⚠ WARNING Keep laundry products out of children's reach. To prevent personal injury, observe all warnings on product labels.

⚠ WARNING Before the washer is removed from service or discarded, remove the washer door to prevent accidental entrapment.

⚠ Failure to comply with these warnings could result in serious personal injuries.

Prevent Injury

⚠ WARNING To prevent shock hazard and assure stability during operation, the washer must be installed and electrically grounded by a qualified service person in accordance with local codes. Installation instructions are packed in the washer for installer's reference. Refer to INSTALLATION INSTRUCTIONS for detailed grounding procedures. If the washer is moved to a new location, have it checked and reinstalled by a qualified service person.

⚠ WARNING To prevent personal injury or damage to the washer, the electrical power cord of the washer must be plugged into a properly grounded and polarized 3-prong outlet. **The third grounding prong must never be removed. Never ground the washer to a gas pipe. Do not use an extension cord or an adaptor plug.**

⚠ WARNING Follow package directions when using laundry products. Incorrect usage can produce poisonous gas--resulting in serious injury or death.

- **Do not** combine laundry products for use in 1 load unless specified on the label.
- **Do not** mix chlorine bleach with ammonia or acids such as vinegar.

⚠ WARNING To prevent serious personal injury and damage to the washer:

- **All repairs and servicing must be performed by an authorized servicer** unless specifically recommended in this Owner's Guide. Use only authorized factory parts.
- **Do not** tamper with controls.
- **Do not** install or store the washer where it will be exposed to the weather.
- **Do not** install on carpet. Install washer on a solid floor. It may be necessary to reinforce the floor to prevent vibration or movement.

⚠ WARNING To reduce the risk of electric shock, disconnect this appliance from the power supply before attempting any user maintenance. Turning the controls to the OFF position does not disconnect this appliance from the power supply.

⚠ WARNING To prevent injury, do not reach into the washer while parts are moving. Before loading, unloading or adding items, push in the cycle selector knob and allow the drum to coast to a complete stop before reaching inside.

⚠ Failure to comply with these warnings could result in serious personal injuries.

⚠ This washer is equipped with an electrical overload protector. The motor will stop if it becomes overheated. The washer will automatically restart after a cool down period of up to 30 minutes, if the washer has not been manually turned off during this time.

B. DETERGENT

- Detergent is flushed from the dispenser at the beginning of the cycle. Either powdered or liquid detergent can be used. **Note:** Liquid detergent will drain into the washer drum as it is added.
- Add a low-sudsing, high-efficiency detergent made for front-loading washers to the dispenser chamber. Look for this symbol on the detergent label. Use the cap or scoop provided by the detergent manufacturer to measure the amount recommended.
- Color-safe bleach, water conditioner, detergent booster and enzyme products may be added to the detergent compartment. Avoid mixing liquids and powders.
- Detergent usage may need to be adjusted for water temperature, water hardness, load size and soil level.
- For best results, avoid oversudsing.

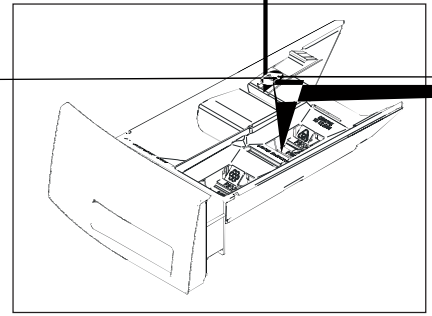

C. LIQUID BLEACH

- If desired, measure out the recommended amount of liquid chlorine bleach (not to exceed 1/3 cup (80 mL)) and pour it into the center compartment labeled "Liquid Bleach" and marked with this symbol .
 - Fill to the minimum fill line (MIN.) for small loads. Fill to the maximum fill line (MAX.) for large loads. Do not exceed the maximum fill line. Overfilling can cause early dispensing of the bleach which could result in damaged clothes.
- Do not pour undiluted liquid chlorine bleach directly onto the load or into the drum. Fabric damage can occur.
 - **Add powder or liquid color-safe bleach to the detergent dispenser.**

D. FABRIC SOFTENER

- If desired, pour the recommended amount of fabric softener into the compartment labeled "Fabric Softener" and marked with this symbol .
- Fill to the minimum fill line (MIN.) for small loads. Fill to the maximum fill line (MAX.) for large loads. Do not exceed the maximum fill line. Overfilling can cause early dispensing of the fabric softener which could result in stained clothes.
- **Do not pour fabric softener directly on the wash load.**
- Use of a fabric softener dispensing ball is not recommended in tumble action washers.

6. Select the cycle, temperature, spin speed, options and features according to type, size, and soil level of each load. Start the washer. (See **Operating Instructions** for your specific model.)

7. Remove items when the cycle is completed.

Place washed items in automatic dryer, line dry, or dry flat as directed by fabric care label. Excess wrinkling, color transfer or odors may develop in items left in the washer after the cycle has ended.

8. General Precautions

- **If the dispenser drawer is opened during operation, the washer will shut off.** Slowly close the dispenser drawer, and press START to continue cycle.
- **Do not slam the washer door closed or try to force the door open when DOOR LOCK light is on.** This could result in damage to the washer.
- **DO NOT leave the washer door open.** An open door could entice children to hang on the door or crawl inside the washer. Note: If there are no small children present, leave the door ajar to prevent odor build up and to improve venting of the unit.
- To avoid damaging the washer and personal injury, DO NOT hang on or lean against the washer door.
- Do not place detergent, bleach or fabric softener containers on top of the washer. They can damage the finish or controls.



Stain Removal

⚠ WARNING Do not use or mix liquid chlorine bleach with other household chemicals such as toilet cleaners, rust removers, acid or products containing ammonia. These mixtures can produce dangerous fumes which can cause serious injury or death.

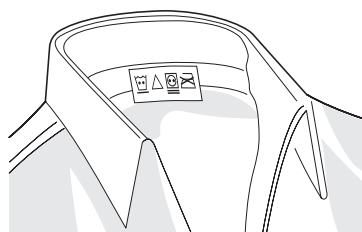
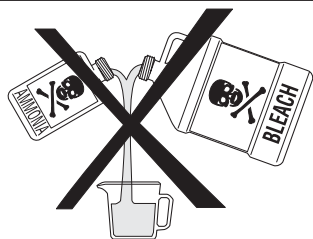

Follow fabric care label instructions.

Safe Stain Removal Procedures

⚠ WARNING To reduce the risk of fire or serious injury to persons or property, comply with the basic warnings listed below:

- Read and comply with all instructions on stain removal products.
- Keep stain removal products in their original labeled containers and out of children's reach.
- Thoroughly wash any utensil used.
- Do not combine stain removal products, especially ammonia and chlorine bleach. Dangerous fumes may result.
- Never wash items which have been previously cleaned in, washed in, soaked in or spotted with gasoline, dry cleaning solvents or other flammable or explosive substances because they give off vapors that could ignite or explode.
- Never use highly flammable solvents, such as gasoline, inside the home. Vapors can explode on contact with flames or sparks.

For successful stain removal:

- Remove stains promptly.
- Determine the kind of stain, then follow the recommended treatment in the stain removal chart below.
- To pretreat stains, use a prewash product, liquid detergent, or a paste made from granular detergent and water.
- Use cold water on unknown stains because hot water can set stains.
- Check care label instructions for treatments to avoid on specific fabrics.
- Check for colorfastness by testing stain remover on an inside seam.
- Rinse and wash items after stain removal.

Stain Removal	
STAIN	TREATMENT
Adhesive tape, chewing gum, rubber cement	Apply ice. Scrape off excess. Place stain face down on paper towels. Saturate with prewash stain remover or nonflammable dry cleaning fluid.
Baby formula, dairy products, egg	Use product containing enzymes to pretreat or soak stains. Soak for 30 minutes or more. Wash.
Beverages (coffee, tea, soda, juice, alcoholic beverages)	Pretreat stain. Wash using cold water and bleach safe for fabric.
Blood	Rinse with cold water. Rub with bar soap. Or, pretreat or soak with product containing enzymes. Wash using bleach safe for fabric.
Candle wax, crayon	Scrape off surface wax. Place stain face down between paper towels. Press with warm iron until wax is absorbed. Replace paper towels frequently. Treat remaining stain with prewash stain remover or nonflammable dry cleaning fluid. Hand wash to remove solvent. Wash using bleach safe for fabric.
Chocolate	Pretreat or soak in warm water using product containing enzymes. Wash using bleach safe for fabric.
Collar or cuff soil, cosmetics	Pretreat with prewash stain remover or rub with bar soap.
Dye transfer on white fabric	Use packaged color remover. Wash using bleach safe for fabric.
Grass	Pretreat or soak in warm water using product containing enzymes. Wash using bleach safe for fabric.
Grease, oil, tar (butter, fats, salad dressing, cooking oils, car grease, motor oils)	Scrape residue from fabric. Pretreat. Wash using hottest water safe for fabric. For heavy stains and tar, apply nonflammable dry cleaning fluid to back of stain. Replace towels under stain frequently. Rinse thoroughly. Wash using hottest water safe for fabric.
Ink	Some inks may be impossible to remove. Washing may set some inks. Use prewash stain remover, denatured alcohol or nonflammable dry cleaning fluid.
Mildew, scorch	Wash with chlorine bleach if safe for fabric. Or, soak in oxygen bleach and hot water before washing. Badly mildewed fabrics may be permanently damaged.
Mud	Brush off dry mud. Pretreat or soak with product containing enzymes.
Mustard, tomato	Pretreat with prewash stain remover. Wash using bleach safe for fabric.
Nail polish	May be impossible to remove. Place stain face down on paper towels. Apply nail polish remover to back of stain. Repeat, replacing paper towels frequently. Do not use on acetate fabrics.
Paint, varnish	WATER BASED: Rinse fabric in cool water while stain is wet. Wash. Once paint is dry, it cannot be removed. OIL BASED AND VARNISH: Use solvent recommended on can label. Rinse thoroughly before washing.
Perspiration	Use prewash stain remover or rub with bar soap. Rinse. Wash using nonchlorine bleach in hottest water safe for fabric.
Rust, brown or yellow discoloration	For spots, use rust remover safe for fabric. For discoloration of an entire load, use phosphate detergent and nonchlorine bleach. Do not use chlorine bleach because it may intensify discoloration.
Shoe polish	LIQUID: Pretreat with a paste of granular detergent and water. PASTE: Scrape residue from fabric. Pretreat with prewash stain remover or nonflammable dry cleaning fluid. Rinse. Rub detergent into dampened area. Wash using bleach safe for fabric.
Urine, vomit, mucus, feces	Pretreat or soak in product containing enzymes. Wash using bleach safe for fabric.

Common Washing Problems

Many washing problems involve poor soil and stain removal, residues of lint and scum, and fabric damage. For satisfactory washing results, follow these suggestions provided by The Soap and Detergent Association.

PROBLEM	POSSIBLE CAUSES	SOLUTIONS	PREVENTIVE MEASURES
Blue stains	<ul style="list-style-type: none"> •Undiluted liquid detergent or fabric softener dispensed directly onto fabric. 	<ul style="list-style-type: none"> •If caused by detergent, mix 1 cup (240 ml) white vinegar with 1 quart (.95 L) water in a plastic container. Soak item 1 hour. Rinse. •If caused by fabric softener, rub stains with bar soap. Wash. 	<ul style="list-style-type: none"> •Avoid overfilling detergent and fabric softener compartments of dispenser.
Discoloration, graying	<ul style="list-style-type: none"> •Not enough detergent. •Wash water temperature too low. •Incorrect sorting. 	<ul style="list-style-type: none"> •Rewash with correct amount of detergent and hottest water safe for fabric. Add bleach safe for fabric. 	<ul style="list-style-type: none"> •Sort items by soil level and color. •Use correct amount of detergent, hottest water and bleach safe for fabric.
Greasy, oily stains	<ul style="list-style-type: none"> •Not enough detergent. •Undiluted liquid fabric softener poured directly on fabric. 	<ul style="list-style-type: none"> •Treat with prewash stain remover or liquid detergent. •Increase detergent and water temperature. Rewash. •Rub fabric softener stains with bar soap. 	<ul style="list-style-type: none"> •Use correct amount of detergent and hottest water safe for fabric. •Do not pour liquid fabric softener directly on fabric. See Washing Procedures for directions on adding softener.
Holes, tears, or snags	<ul style="list-style-type: none"> •Incorrect use of chlorine bleach. •Unfastened zippers, hooks, buckles. •Rips, tears and broken threads. •Overloading the washer. •Degradation of fabric. 	<ul style="list-style-type: none"> •May be irreversible if rips, tears and seams cannot be mended. 	<ul style="list-style-type: none"> •Never pour chlorine bleach directly on fabric. •Check condition of items before washing. See Washing Procedures for preparing and loading the wash load and adding chlorine bleach.
Lint	<ul style="list-style-type: none"> •Incorrect sorting. •Tissues left in pocket. •Overloading the washer. •Not enough detergent. •Undissolved detergent has left a residue resembling lint. •Static cling is attracting lint. •Load washed too long. 	<ul style="list-style-type: none"> •Reduce load size. Rewash using correct water temperature, water level, and amount of detergent. •Add nonprecipitating water conditioner to wash water to remove detergent residue. •Add liquid fabric softener to final rinse. •Dry load in dryer. •Remove lint with lint brush or roller. 	<ul style="list-style-type: none"> •See Washing Procedures for sorting and preparing the wash load. •Do not overload washer. •Use correct temperature and amount of detergent, water and wash time.
Pilling (Fibers break off, ball up and cling to fabric.)	<ul style="list-style-type: none"> •Pilling is normal with synthetic and permanent press fabrics. This is due to abrasion from normal wear. 	<ul style="list-style-type: none"> •Use a lint brush or shaver to remove pills. 	<ul style="list-style-type: none"> •Use fabric softener in the washer to lubricate fibers. •When ironing, use spray starch or fabric finish on collars and cuffs. •Turn items inside out to reduce abrasion.
Residue or powder on dark items; Stiff, harsh fabrics.	<ul style="list-style-type: none"> •Undissolved detergent. •Some nonphosphate granular detergents can combine with hard water minerals to form a residue. •Overloading the washer. 	<ul style="list-style-type: none"> •Rewash load. 	<ul style="list-style-type: none"> •Increase water temperature using hottest water safe for fabric. •Do not overload washer. •Use liquid detergent or use nonprecipitating water conditioner with nonphosphate granular detergent.
Wrinkling	<ul style="list-style-type: none"> •Overloading the washer. •Incorrect wash cycle for wash load. 	<ul style="list-style-type: none"> •Reduce load size. •Rinse in cold water with liquid fabric softener using the Perm Press or Delicate cycle. 	<ul style="list-style-type: none"> •Do not overload washer. •Remove items from washer as soon as cycle is completed. •Use liquid fabric softener.
Yellow buildup of body soil on synthetic fabrics	<ul style="list-style-type: none"> •Agitation time too short. •Wash water temperature too low. •Not enough detergent. 	<ul style="list-style-type: none"> •Soak in detergent booster or product containing enzymes. •Wash in hot water (120°F/49°C) using full permanent press cycle. Increase detergent. Add bleach safe for fabric. •Or, treat with color remover. 	<ul style="list-style-type: none"> •Select correct wash cycle. •Use correct amount of detergent. •Wash synthetics frequently using hot or warm water.
Yellow or brown rust stains	<ul style="list-style-type: none"> •Iron or manganese in water supply, water pipes, or water heater. 	<ul style="list-style-type: none"> •To restore discolored load of whites, use rust remover safe for fabric. •Do not use chlorine bleach to remove rust stains. It may intensify discoloration. 	<ul style="list-style-type: none"> •Use nonprecipitating water softener. •Before washing, run hot water for a few minutes to clear lines. •Drain water heater occasionally. •For an ongoing problem, install an iron filter in your water supply system.

Care and Cleaning

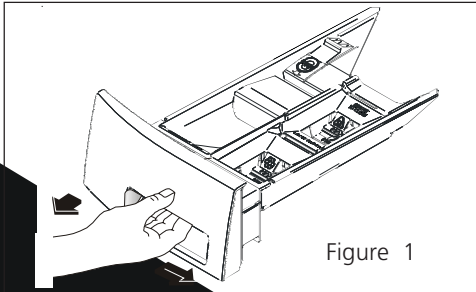

Figure 1

(Lock tab is visible only after drawer has been pulled out.)

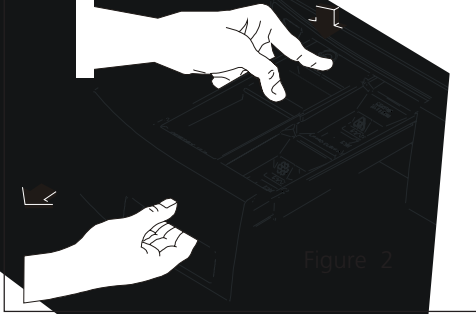

Figure 2

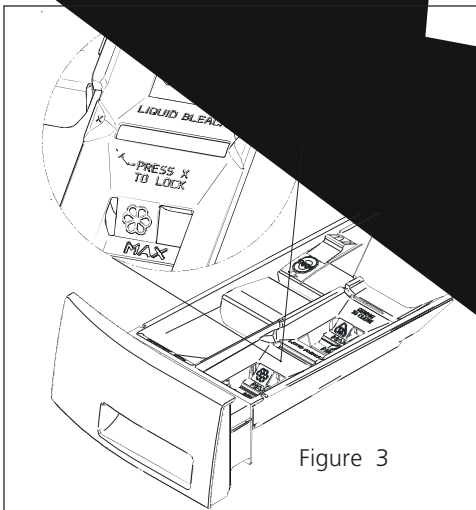

Figure 3

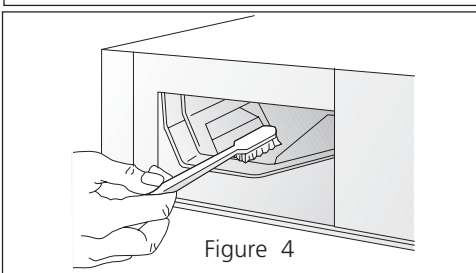

Figure 4

Follow Winterizing Instructions for cold weather care.

Outside

- When washing is completed, wipe top and sides of washer with a damp cloth. Turn water faucets off to prevent pressure buildup in the hoses.
- As needed, clean the cabinet with mild soap and water. **Never use harsh, gritty or abrasive cleansers** on door or control panel. If control panel becomes stained, clean with diluted chlorine bleach [1/2 cup (120 ml) in 1 quart (.95 L) water]. Rinse several times with clean water.
- Remove glue residue from tape or labels with a mixture of warm water and mild detergent. Or, touch residue with the sticky side of the tape or label.
- **Before moving the washer**, place a strip of cardboard or thin plywood under the leveling legs to prevent floor damage.

Cleaning the Dispenser Drawer Area

Detergent and fabric softener may build up in the dispenser drawer. Residue should be removed once or twice a month.

- Remove the drawer by first sliding the safety latch to the right, then pulling the drawer out until it stops. (Figure 1)
- Reach back into the left rear corner of the drawer cavity and press down firmly on the lock tab (left rear portion of the drawer). Pull out the drawer. (Figure 2)
- Remove the insert from the bleach and fabric softener compartments. (Figure 3)
- Rinse the drawer and inserts with hot tap water to remove traces of accumulated powder and liquids. Large amounts of fabric softener residue may indicate improper dilution or more frequent cleaning is required.
- To clean the drawer opening, use a small brush to clean the recess. Remove residue from the upper and lower parts of the recess. (Figure 4)
- Replace the insert, pressing the "X" to lock it in place. Return the dispenser drawer.

Inside

- Remove items from the washer as soon as the cycle ends. Excess wrinkling, color transfer, and odors may develop on items left in the washer.
- Before cleaning the washer interior, **unplug the electrical power cord** to avoid electric shock hazards.
- Dry around the washer door opening, flexible gasket, and door glass. These areas should always be clean to ensure a water tight seal.
- When extremely soiled items have been washed, a dirty residue may remain on the drum. Remove this by wiping the drum with a nonabrasive household cleanser. Rinse thoroughly with water.
- Periodically, wipe dry the fold-in the bottom of the flexible gasket to remove lint and other debris.
- The plastic drum panels may become stained from fabric dye. Clean these parts with a nonabrasive household cleanser. This prevents dye transfer to future loads.

- Do not store or move in freezing temperatures, or use the washer.

6. Remove all the items from the wash drum.

Avoid Service Checklist

Before calling for service, review this list. It may save both time and expense. The list includes common concerns that are not the result of defective workmanship or materials in this washer.

OCCURRENCE

POSSIBLE CAUSE / SOLUTION

NOISE

High pitch "jet engine" noise.

- A certain amount of motor whine is normal during the spin cycle.

Rattling and clanking noise.

- Foreign objects such as coins or safety pins may be in drum or pump. Stop washer and check drum. If noise continues after washer is restarted, objects may be in pump. Call your authorized servicer.
- Belt buckles and metal fasteners are hitting wash drum. To prevent unnecessary noise and damage to drum, fasten fasteners and turn items inside out.

Squealing sound or hot rubber odor.

- Washer is overloaded. Do not overload washer. Stop washer and reduce load.

Thumping sound.

- Heavy wash loads may produce a thumping sound. This is usually normal. If sound continues, washer is probably out of balance. Stop washer and redistribute wash load.

Vibrating noise.

- Washer is not resting firmly on floor. Move washer so it rests firmly on floor. Adjust leveling legs and tighten lock nuts. See INSTALLATION INSTRUCTIONS for details.
- Shipping bolts and foam block have not been removed during installation. See INSTALLATION INSTRUCTIONS for removing shipping bolts and foam block.
- Wash load unevenly distributed in drum. Stop washer and rearrange wash load.

OPERATING

Washer does not start.

- Electrical power cord may not be plugged in or connection may be loose. Make sure plug fits tightly in wall outlet.
- House fuse blown, circuit breaker tripped, or a power outage has occurred. Reset circuit breaker or replace fuse. Do not increase fuse capacity. If problem is a circuit overload, have it corrected by a qualified electrician. If problem is a power outage, call local electric company.
- Water supply faucets are not turned on. Turn on water supply faucets.
- Motor is overheated. Washer motor will stop if it becomes overheated. It will automatically restart after a cool down period of up to 30 minutes (if washer has not been manually turned off).
- Dispenser drawer is open. Close drawer.
- Washer door is not completely closed. Close door completely.

Washer won't spin.

- Load is too small. Add 1 or 2 similar items to help balance the load.
- Dispenser drawer is open. Close drawer.

Residue left in drum.

- Heavily soiled items. Wipe drum with a nonabrasive household cleanser, then rinse. Shake or brush excess dirt and sand from items before washing

WATER

Water collects in folds of the bellows at the end of the cycle.

- This is a result of the washing action and is part of the normal operation of the washer.

Water collects in bleach and fabric softener compartments.

- This is a result of the siphoning action and is part of the normal operation of the washer. Water may be removed by removing the dispenser drawer (see Page 7, Figures 1 and 2) and draining water into the empty drum or sink.

Wash load too wet after spin.

- Washer is overloaded. Do not overload washer. See **Washing Procedures**.
- Load is too small. Add 1 or 2 similar items to help balance the load.
- Load is out of balance. Rearrange load to allow proper spinning.
- Drain hose is kinked. Straighten drain hose.

Water does not enter washer or it enters slowly.

- Water supply is not adequate in area. Check another faucet in the house. Wait until water supply and pressure increase.
- Water supply faucets are not completely open. Fully open hot and cold faucets.
- Water is being used elsewhere in the house. Water pressure must be at least 30 psi (260 kPa). Avoid running water elsewhere while washer is filling.
- Water inlet hoses are kinked. Straighten hoses.

Warm or hot water is not hot enough.

- Hot water heater is set too low or is a distance from washer. Measure hot water temperature at nearby faucet with candy or meat thermometer. Water temperature should be at least 120°F (49°C). Adjust water heater as necessary.
- Hot water is being used elsewhere in the house. Avoid using hot water elsewhere before or during washer use. There may not be enough hot water available for proper cleaning. If problem persists, your hot water system may be unable to support more than 1 use at a time.

Water in washer does not drain or drains slowly.

- Drain hose is kinked or clogged. Clean and straighten the drain hose.
- Maximum standpipe height is 8' (2.4 m).
- House drain pipes are clogged. Unclog drain pipes. Contact plumber if necessary.

Water leaks.

- Fill hose connection is loose at faucet or washer. Check and tighten hose connections. Install rubber sealing washers provided.

Oversudsing.

- Wrong detergent. Run rinse cycle. Use a low-sudsing, high efficiency detergent.
- Too much detergent. Run rinse cycle. Use less detergent in future loads

Incorrect wash and rinse temperatures.

- Hot and cold water hoses are connected to wrong supply faucets. Connect hot water hose to hot water faucet and cold water hose to cold water faucet.

Water is entering washer but tub does not fill.

- Drain hose standpipe is incorrect height. Standpipe must be a minimum of 23.6" (60 cm) high to prevent siphoning. See INSTALLATION INSTRUCTIONS.

Major Appliance Warranty Information

Your appliance is covered by a one year limited warranty. For one year from your original date of purchase, Electrolux will pay all costs for repairing or replacing any parts of this appliance that prove to be defective in materials or workmanship when such appliance is installed, used and maintained in accordance with the provided instructions.

Exclusions **This warranty does not cover the following:**

1. Products with original serial numbers that have been removed, altered or cannot be readily determined.
2. Product that has been transferred from its original owner to another party or removed outside the USA or Canada.
3. Rust on the interior or exterior of the unit.
4. Products purchased "as-is" are not covered by this warranty.
5. Food loss due to any refrigerator or freezer failures.
6. Products used in a commercial setting.
7. Service calls which do not involve malfunction or defects in materials or workmanship, or for appliances not in ordinary household use or used other than in accordance with the provided instructions.
8. Service calls to correct the installation of your appliance or to instruct you how to use your appliance.
9. Expenses for making the appliance accessible for servicing, such as removal of trim, cupboards, shelves, etc., which are not a part of the appliance when it is shipped from the factory.
10. Service calls to repair or replace appliance light bulbs, air filters, water filters, other consumables, or knobs, handles, or other cosmetic parts.
11. Surcharges including, but not limited to, any after hour, weekend, or holiday service calls, tolls, ferry trip charges, or mileage expense for service calls to remote areas, including the state of Alaska.
12. Damages to the finish of appliance or home incurred during installation, including but not limited to floors, cabinets, walls, etc.
13. Damages caused by: services performed by unauthorized service companies; use of parts other than genuine Electrolux parts or parts obtained from persons other than authorized service companies; or external causes such as abuse, misuse, inadequate power supply, accidents, fires, or acts of God.

DISCLAIMER OF IMPLIED WARRANTIES; LIMITATION OF REMEDIES

CUSTOMER'S SOLE AND EXCLUSIVE REMEDY UNDER THIS LIMITED WARRANTY SHALL BE PRODUCT REPAIR OR REPLACEMENT AS PROVIDED HEREIN. CLAIMS BASED ON IMPLIED WARRANTIES, INCLUDING WARRANTIES OF MERCHANTABILITY OR FITNESS FOR A PARTICULAR PURPOSE, ARE LIMITED TO ONE YEAR OR THE SHORTEST PERIOD ALLOWED BY LAW, BUT NOT LESS THAN ONE YEAR. ELECTROLUX SHALL NOT BE LIABLE FOR CONSEQUENTIAL OR INCIDENTAL DAMAGES SUCH AS PROPERTY DAMAGE AND INCIDENTAL EXPENSES RESULTING FROM ANY BREACH OF THIS WRITTEN LIMITED WARRANTY OR ANY IMPLIED WARRANTY. SOME STATES AND PROVINCES DO NOT ALLOW THE EXCLUSION OR LIMITATION OF INCIDENTAL OR CONSEQUENTIAL DAMAGES, OR LIMITATIONS ON THE DURATION OF IMPLIED WARRANTIES, SO THESE LIMITATIONS OR EXCLUSIONS MAY NOT APPLY TO YOU. THIS WRITTEN WARRANTY GIVES YOU SPECIFIC LEGAL RIGHTS. YOU MAY ALSO HAVE OTHER RIGHTS THAT VARY FROM STATE TO STATE.

If You Need Service

Keep your receipt, delivery slip, or some other appropriate payment record to establish the warranty period should service be required. If service is performed, it is in your best interest to obtain and keep all receipts. Service under this warranty must be obtained by contacting Electrolux at the addresses or phone numbers below.

This warranty only applies in the USA and Canada. In the USA, your appliance is warranted by Electrolux Major Appliances North America, a division of Electrolux Home Products, Inc. In Canada, your appliance is warranted by Electrolux Canada Corp. Electrolux authorizes no person to change or add to any obligations under this warranty. Obligations for service and parts under this warranty must be performed by Electrolux or an authorized service company. Product features or specifications as described or illustrated are subject to change without notice.

USA
1.800.944.9044
Electrolux Major Appliances
North America
P.O. Box 212378
Augusta, GA 30907



Canada
1.800.668.4606
Electrolux Canada Corp.
5855 Terry Fox Way
Mississauga, Ontario, Canada
L5V 3E4